

**i** SPOT 1200

**coemar**

**manuale  
di istruzioni  
instructions  
manual**

**1<sup>^</sup> edizione, Novembre 2004  
1<sup>st</sup> edition, November 2004**



# ISPOT 1200

numero di serie/serial number

data di acquisto/date of purchase

fornitore/retailer

indirizzo/address

cap/città/suburb

provincia/capital city

stato/state

tel./fax/

Please note in the space provided above the relative service information of the model and the retailer from whom you purchased your **I-Spot 1200**: This information will assist us in providing spare parts, repairs or in answering any technical enquiries with the utmost speed and accuracy.

**WARNING:** the security of the fixture is granted only if these instructions are strictly followed; therefore it is absolutely necessary to keep this manual.

# Index

<b>1. Packaging</b>	Pag. 5
<b>2. Transportation</b>	.. 5
<b>3. Important safety information</b>	.. 5
<b>4. Lamp: installation and replacement</b>	.. 6
<b>5. Operating voltage and frequency</b>	.. 7
<b>6. Installation</b>	.. 8
<b>7. Mains connection</b>	.. 9
<b>8. Signal connection</b>	.. 10
<b>9. Powering up</b>	.. 11
<b>10. DMX addressing</b>	.. 11
<b>11. Display panel functions</b>	.. 12
<b>11.1. Function settings (FUNC)</b>	.. 12
<b>11.2. Measure and test (MEAS)</b>	.. 13
<b>11.3. Quick guide to menu navigation</b>	.. 14
<b>11.4. Rapid scrolling</b>	.. 14
<b>12. Aligning the lamp in the optical path</b>	.. 15
<b>13. Turning on the ISPOT 1200 with no articulated movement</b>	.. 16
<b>14. Resetting the counter</b>	.. 16
<b>15. Automatic realignment</b>	.. 16
<b>16. DMX 512 signal functions</b>	.. 17
<b>17. Opening up the projector</b>	.. 20
<b>18. Gobo positioning</b>	.. 21
<b>19. Interchanging gobos</b>	.. 22
<b>20. Altering the operating voltage (Reserved for technical personnel)</b>	.. 24
<b>20.1. Selecting the transformer voltage</b>	.. 24
<b>21. Thermal protection</b>	.. 25
<b>22. Lamp circuit protection</b>	.. 25
<b>23. Maintenance</b>	.. 25
<b>24. Electronic motor alignment</b>	.. 26
<b>25. Error messages</b>	.. 27
<b>26. Spare parts</b>	.. 28
<b>27. Troubleshooting</b>	.. 28

Congratulations on having purchased a coemar product. You have assured yourself of a fixture of the highest quality, both in componentry and in the technology used. We renew our invitation to you to complete the service information on the previous page, to expedite any request for service information or spares (in case of problems encountered either during, or subsequent to, installation). This information will assist in providing prompt and accurate advice from your coemar service centre.

## 1. Packaging

Following the instructions and procedures outlined in this manual will ensure the maximum efficiency of this product for years to come.

Open the packaging and ensure that no part of the equipment has suffered damage in transit. In case of damage to the equipment, contact your carrier immediately by telephone or fax, following this with formal notification in writing.

Ensure the packaging contains:

- 1 **ISPOT 1200**
- 1 **instruction manual**
- 2 **cam-lock projector supports**

## 2. Transportation

The **ISPOT 1200** should be transported in its original packaging or in a coemar approved flight case.

In order to manufacture a suitable flight case, we recommend the following simple procedure to be followed, which will stop the articulated movement of the **ISPOT 1200**.

## 3. Important safety information

### Fire prevention:

1. **ISPOT 1200** utilises a Philips **MSI1200W/s** or Osram **HMI 1200W/s lamp**; the use of any alternative lamp is not recommended and will null and void the fixture's warranty.
2. Never locate the fixture on any flammable surface.
3. Minimum distance from flammable materials: 0,5 m.
4. Minimum distance from the closest illuminable surface: 2 m.
5. Replace any blown or damaged fuses only with those of identical values. Refer to the schematic diagram if there is any doubt.
6. Connect the projector to mains power via a thermal magnetic circuit breaker.

### Preventing electric shock:

1. When connecting the **ISpot 1200** to mains power, the instructions in this manual should be followed carefully.
2. The level of technology inherent in the **iSpot 1200** requires the use of specialised personnel for all service applications; refer all work to your authorised **coemar** service centre.
3. A good earth connection is essential for proper functioning of the projector. Never operate the unit without proper earth connection.
4. High voltage is present in the internals of the unit. Isolate the projector from mains supply prior to performing any function which involves touching the internals of the unit, including lamp replacement.
5. The mains cable should not come into contact with other cables.  
Always handle the mains cable and all other cables connected to the unit with extreme caution.  
Never handle the **ISpot 1200** with wet hands.
6. Ensure that the mains voltage applied is the recommended voltage for the projector.
7. Never install the projector in locations which may be exposed to rain, high humidity or which lack suitable air flow.

### Protection against ultraviolet radiation:

1. Never turn on the lamp if any of the lenses, filters, or the carbon fibre housing is damaged; their respective functions will only operate efficiently if they are in perfect working order.
2. Never look directly into the lamp when it is operating.

### Safety:

1. The projector should always be installed with bolts, clamps, and other fixings which are suitably rated to support the weight of the unit.
2. Always use a secondary safety chain of a suitable rating to sustain the weight of the unit in case of the failure of the primary fixing point.
3. The external surface of the unit, at various points, may exceed 150°C. Never handle the unit until at least 10 minutes have elapsed since the lamp was turned off.
4. Always replace the lamp if any physical damage is evident.
5. Never install the fixture in an enclosed area lacking sufficient air flow; the ambient temperature should not exceed 35°C.
6. A hot lamp may explode. Always wait for at least 10 minutes to elapse after the unit has been turned off prior to attempting to replace the lamp.  
Always wear suitable hand protection when handling the lamp.

### Protection rating against penetration by external agents:

1. The fixture is classified ordinary device ; its protection grade against penetration by external agents,solid or liquid, is IP 20

## 4. Lamp: installation and replacement

**ISPOT 1200** utilises a Philips MSI 1200w/s or Osram HMI 1200W/s lamp rated at 1200W with a SFc10-4 lampbase. The lamp is available from your authorised coemar sales agent:

<b>Philips MSI 1200W/S</b>		<b>Osram HMI 1200W/S</b>	
coemar cod.	105099/2	coemar cod.	105099/1
base	SFc10-4	base	SFc10-4
power	1200 w	power	1200 w
luminous flux	lm 110.000	luminous flux	lm 110.000
colour temperature	Tc 6000°K	colour temperature	Tc 6000°K
approximate lamp life	750 hr	approximate lamp life	750 hr

### Attention

Turn off mains power prior to opening up the unit

The fixtures internal temperature can reach 250° C after 5 minutes, with a maximum peak of 350° C; ensure that the lamp is cold prior to attempting removal. The fixture should be allowed to stand and cool for 10 minutes prior to its removal. The lamps are part of the mercury vapour family of discharge lamps and must be handled with great care. The lamp operates at high pressure, and the slight risk of explosion of the lamp exists if operated over their recommended lives. We recommend, therefore, that the lamp be replaced within the manufacturer's specified lamp life.

### installing the lamp

1) Remove the 4 screws at the rear of the projector body, as shown in the diagram below.

Fig.1



2) Remove the lampholder assembly.

Fig.2



3) Insert the lamp, taking care not to come into contact with the lamp's quartz glass surface.

Fig.3





4) Replace the lampholder assembly and the 4 screws removed in step 1.(see Fig.1)

## 5. Operating voltage

The projector may operate at voltages including 208, 230 or 240 V. **Coemar** presets (barring specific requests) an operating voltage of 240v.

The preset voltage is indicated on a sticker located on the base of the projector power on/off switch as shown in the diagram below. **ISPOT 1200** may operate at either 50 or 60 Hz without any changes required.

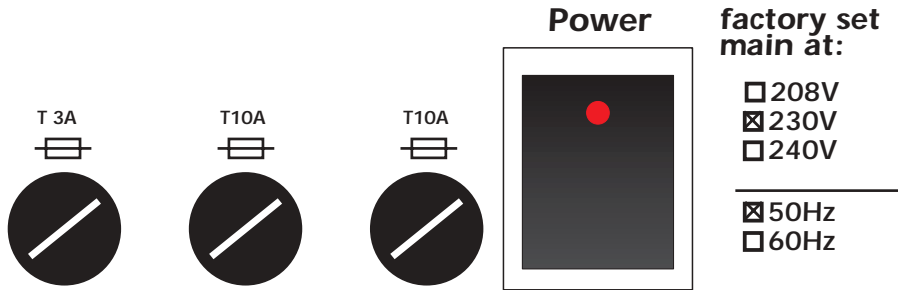

### selecting an operating voltage different to the factory preset

If the preset operating voltage does not correspond with the voltage in use in the country in which the projector is to operate, it is possible to alter the operating voltage of the projector at any time. See section **20. Altering the operating voltage**  
**An error in voltage selection may cause serious damage to the projector.**

## 6. Installation

### installation

**ISPOT 1200** may be either floor or ceiling mounted.

For floor mounting installations, the **ISPOT 1200** is provided with four rubber mounting feet

For truss mounted installations **coemar** includes 2 cam-lock mounting devices (**A**).

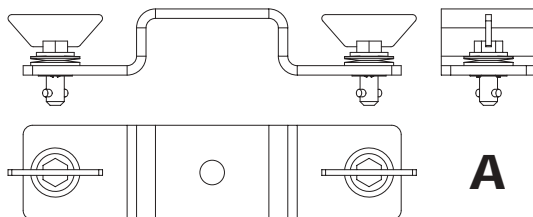

You may fit the cam-locks in 2 different positions on the base of the **ISPOT 1200**. The cam-lock fittings are of the type which need a 1/4 turn. To be used correctly the fittings must be correctly fitted with some care.

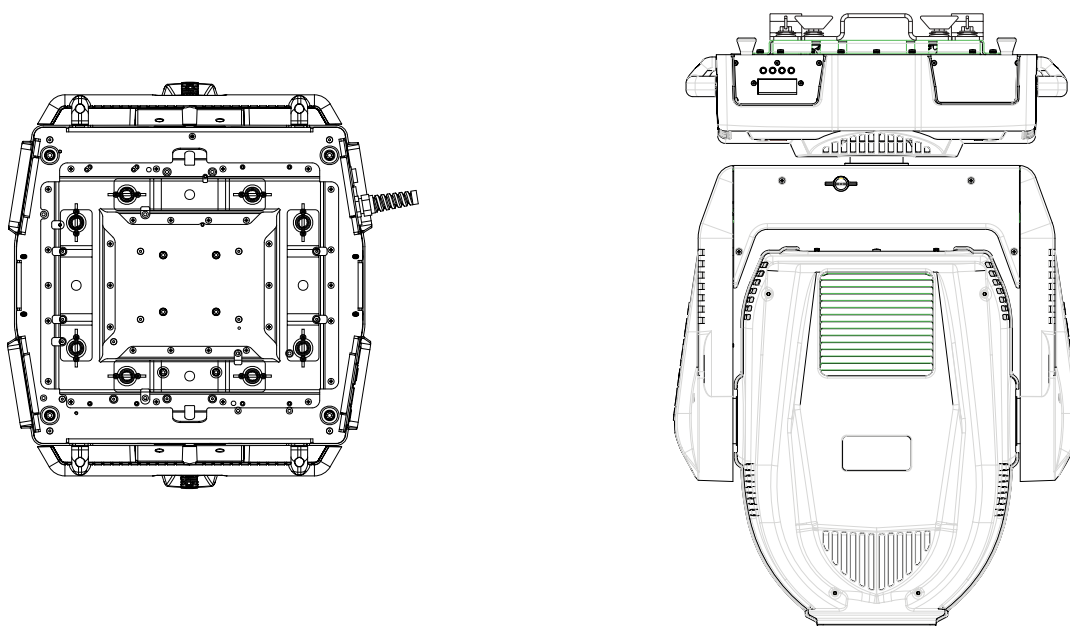

If suspending the units we recommend the use of an appropriate structure and suspension clamps able to sustain the weight of the unit. Clamps may be fitted to the central position of the cam-lock fixtures.

### Attention

Always use two clamps per projector

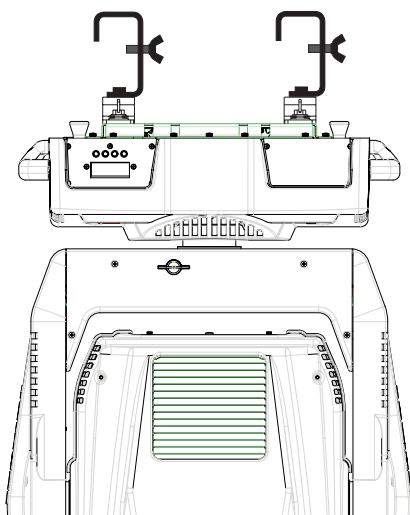

The structure from which the unit is hung should be of sufficient rating to hold the weight of the unit, as should any clamps used to hang the unit. The structure should also be sufficiently rigid so as not to move or shake whilst the **ISPOT1200** moves during its operation.



### safety chains

We recommend the use of a safety chain fitted through the "B" slot of the **ISPOT 1200** and to the suspension truss in order to avoid the fixture accidentally falling. If using an after-market safety chain not manufactured by **coemar**, ensure that it is of sufficient rating to hold the weight of the unit.

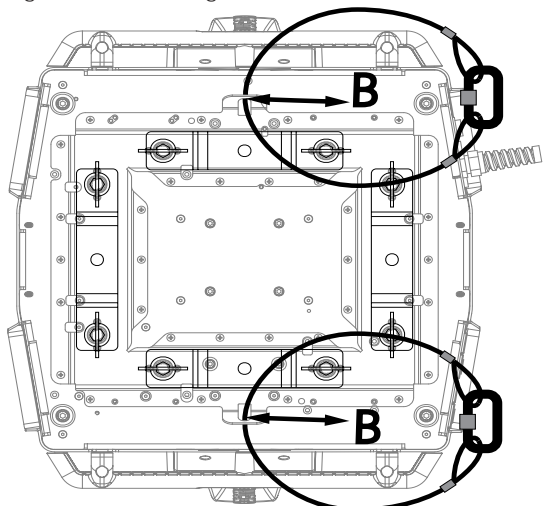

### protection against liquids

The projector contains electric and electronic components that must not come into contact with water, oil, or any other liquid.

### movement

The projector has a maximum movement of 360° in the base and 260° in the yoke; **DO NOT** place any obstructions in the path of the projector's movement.

### risk of fire

Each fixture produces heat and must be installed in a well-ventilated position. The minimum recommended distance from flammable material is: 0.5m. Minimum distance from the object being illuminated is: 2m.

### forced ventilation

You will note that the projector features several air inlets and cooling fans, located at the rear of the projector and on the base. Under no circumstances should these be obstructed.

Obstruction of these cooling features may cause the fixture to overheat and may result in serious damage occurring.

### ambient temperature

Never install the fixture in an enclosed area lacking sufficient air flow; the ambient temperature should not exceed 35°C.

## 7. Mains connection

### cabling

The mains cable provided is thermally resistant, complying to the most recent international standards. It meets or exceeds VDE and IEC norms, IEC 331, IEC 332 3C, CEI 20 35.

NB: In case of cable replacement, similar cable with comparable thermal resistant qualities must be used exclusively (cable 3x1.5 ø external 10 mm, rated 300/500V, tested to 2KV, operating temperature -40° +180°, **coemar** cod. CV5309).

### Mains connection

**ISPOT 1200** can operate at voltages from 208V-230V-240V at 50 or 60Hz (operating voltage and frequency can be selected as described in section 5 of this manual).

Prior to connecting the unit to your mains supply, ensure that the model in your possession correctly matches the mains supply available to you. For connection purposes, ensure your plug is of a suitable rating of 7 amps. Locate the mains cable which exits the base of the unit and connect as shown below:

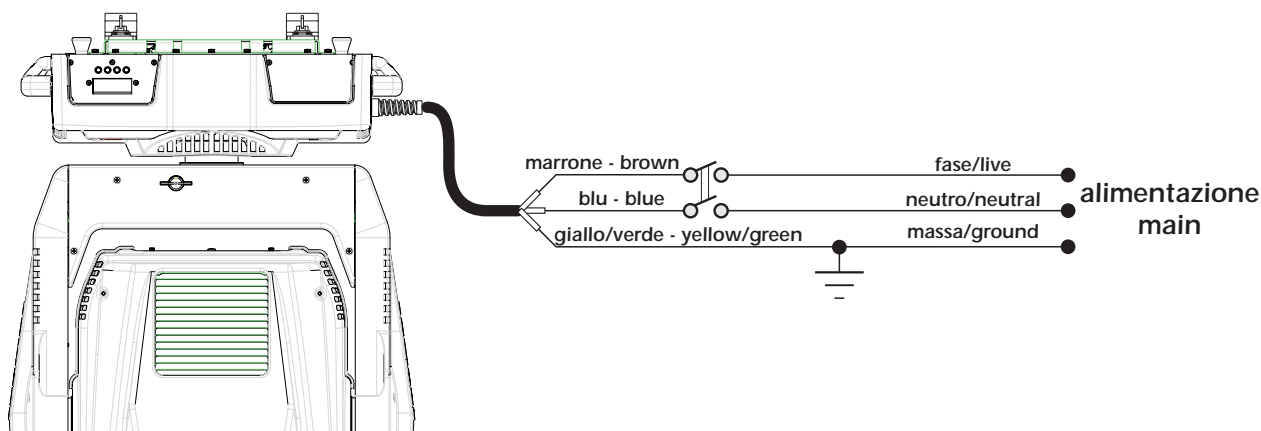

### protection

The use of a thermal magnetic circuit breaker is recommended for each **ISPOT 1200**.

A good earth connection is essential for the correct operation of the fixture. Strict adherence to regulatory norms is strongly recommended.

## 8. Signal connection

Control signal is digital, and is transmitted via two pair screened  $\varnothing 0.5\text{mm}$  cable.

Connection is serial, utilising XLR 3 or XLR5 male and female sockets located on the base of the **ISPOT 1200**, labeled **DMX 512 In** and **OUT** (see diagram).

Pin connections conform to the international standard:

- pin 1= screening 0 volt
- pin 2= data -
- pin 3= data +

If using a controller which output signal via an XLR 5 (5 pin) socket, do not use pins 4 and 5, leaving them unconnected.

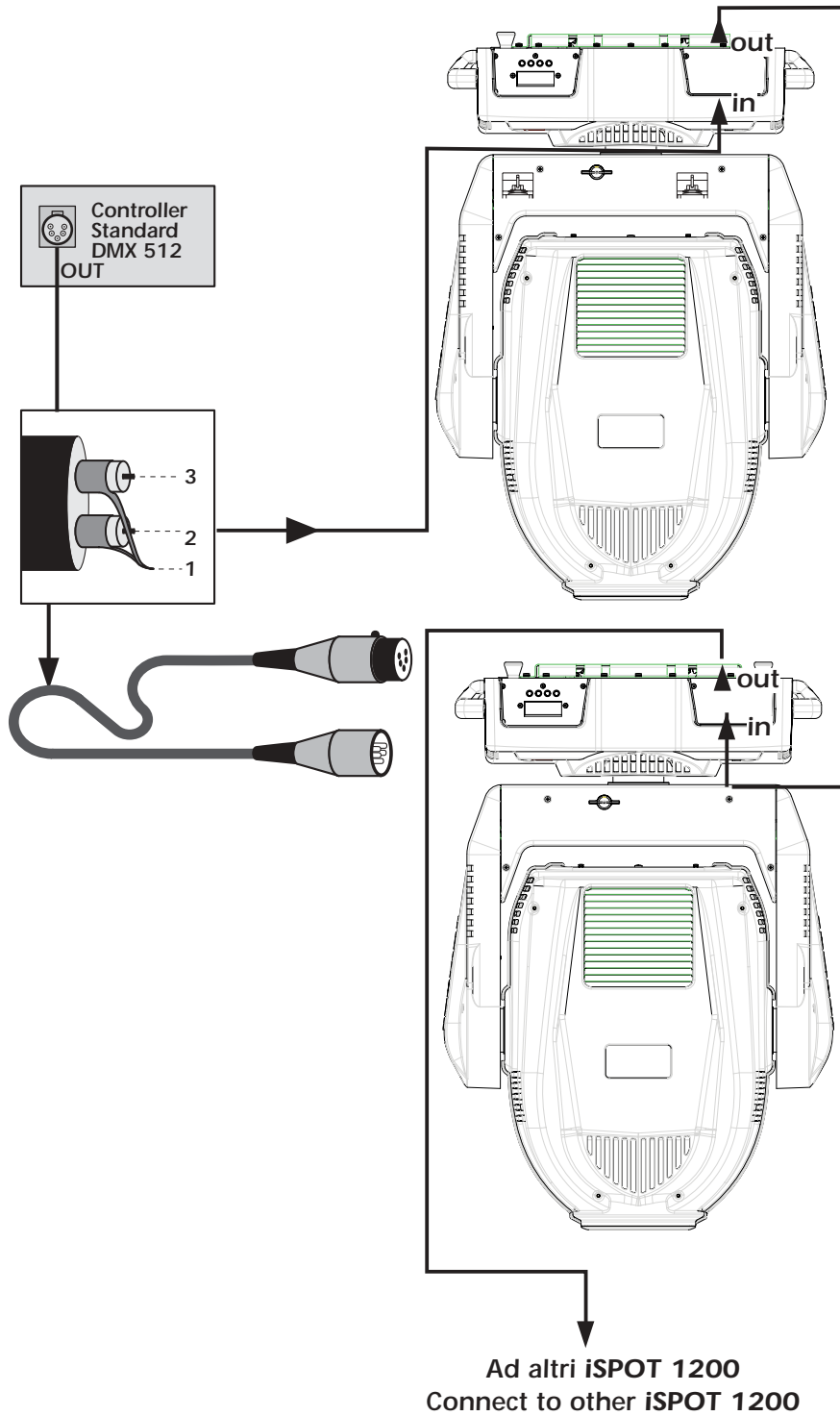

Ensure that all data conductors are isolated from one another and the metal housing of the connector.

**Note: the housing of the cannon XLR 3 or 5 must be isolated.**

## 9. Powering up

After having followed the preceding steps, turn on the DMX 512 controller which will be used to control the fixture. Following this, turn on the power to the projector, and turn on the projector's power switch. The projector will perform a reset function on all the internal and external motors. This will last some few seconds, after which it will be subject to the external signal from the controller.

### Software version

Three groups of software operate within the system; some in the display microprocessor of the unit "D" and some in the master microprocessor "A" and "B". On powering up the display will briefly show the current versions of the installed software: For example, the **Ispot 1200** may show:

**D1.00** (display software "D" version 1.00)

**A1.03** (master software in position "A" version 1.03)

**B1.10** (master software in position "B" version 1.10)

### DMX signal reception

After the display of software versions installed in the units microprocessors, the projector will reset and the display will be fixed on to show that **DMX 512** is being correctly received by the projector. If the display flashes, the projector is not receiving signal. Check that the cabling is connected correctly and that the controller is operating properly.

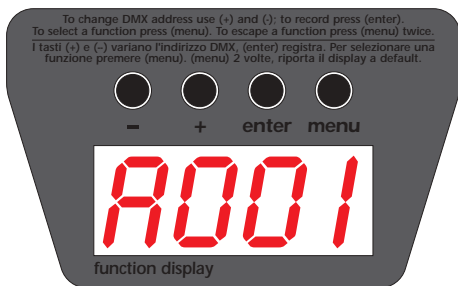

## 10. DMX addressing

Each projector utilises **24** channels of DMX 512 signal for complete control. (see section **24. DMX 512 channel functions** for further information)

### DMX addressing

To ensure that each projector accesses the correct signal, it is necessary to correctly address each **ISPOT 1200**.

When powered up initially, each projector will show **A001** indicating **DMX address 1**: a projector thus addressed will respond to commands on channels **1** to **24** from the **DMX 512 controller**. A second unit should be addresses as **25**, a third as **49** and so on until the final **ISPOT 1200** has been addressed.

### altering DMX addresses

- 1) Press the **+** or **-** button until the display shows the **DMX** required, the characters in the display panel will flash to indicate that the selection is not stored in memory.

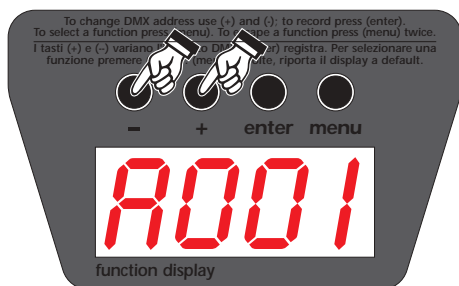

- 2) Press the **enter** button to confirm your selection; the display will stop flashing and the projector will now respond to the new DMX address.
- 3) To better understand the function of each channel, we refer you to section **12. DMX 512 channel functions**

**Important Note:** Keeping the **+** or **-** button pressed will cause the display to alter at increased speed, allowing a faster selection to be effected.

# 11. Display panel functions

The display panel of **ISPOT 1200** shows all the functions available; it is possible to change some of those parameters and to add some functions.

Changing the setting made by coemar can vary the functions of the device so that it will not respond to the **DMX 512** controller used to control it. Carefully follow the instructions before applying any variations or selections.

**NOTE:** the symbol  shows which key has to be pushed to obtain the function desired.

## 11.1. Function settings (FUNC)

The projector allows the altering of several functions and select personalised settings.

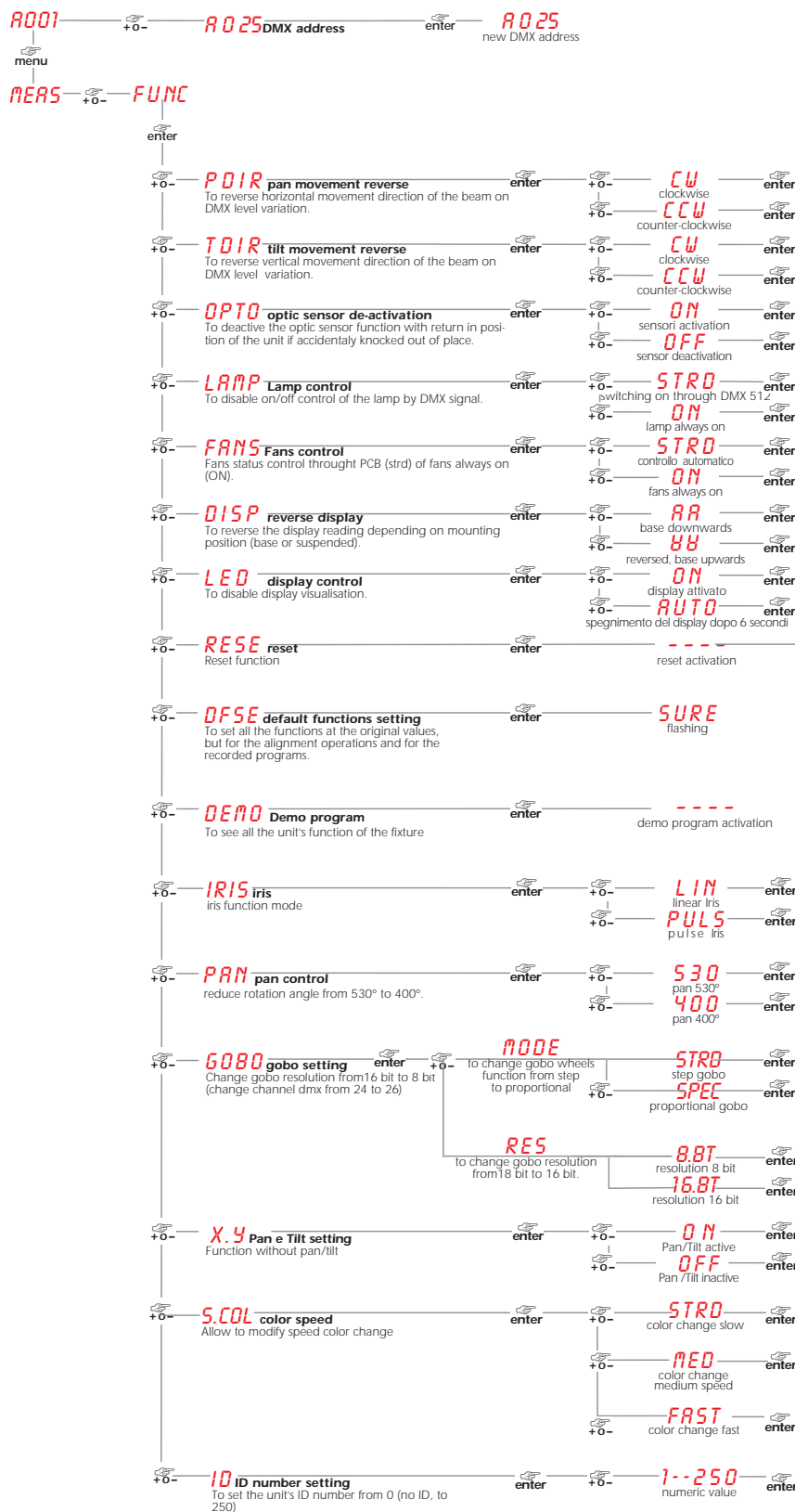

## 11.2. Measure and test (MEAS)

The internal microprocessor of the **ISPOT 1200** allows for several diagnostic and output parameters to be displayed. You may record, in this menu, the position in which the projector will come to rest when turned on with no dmx signal attached.

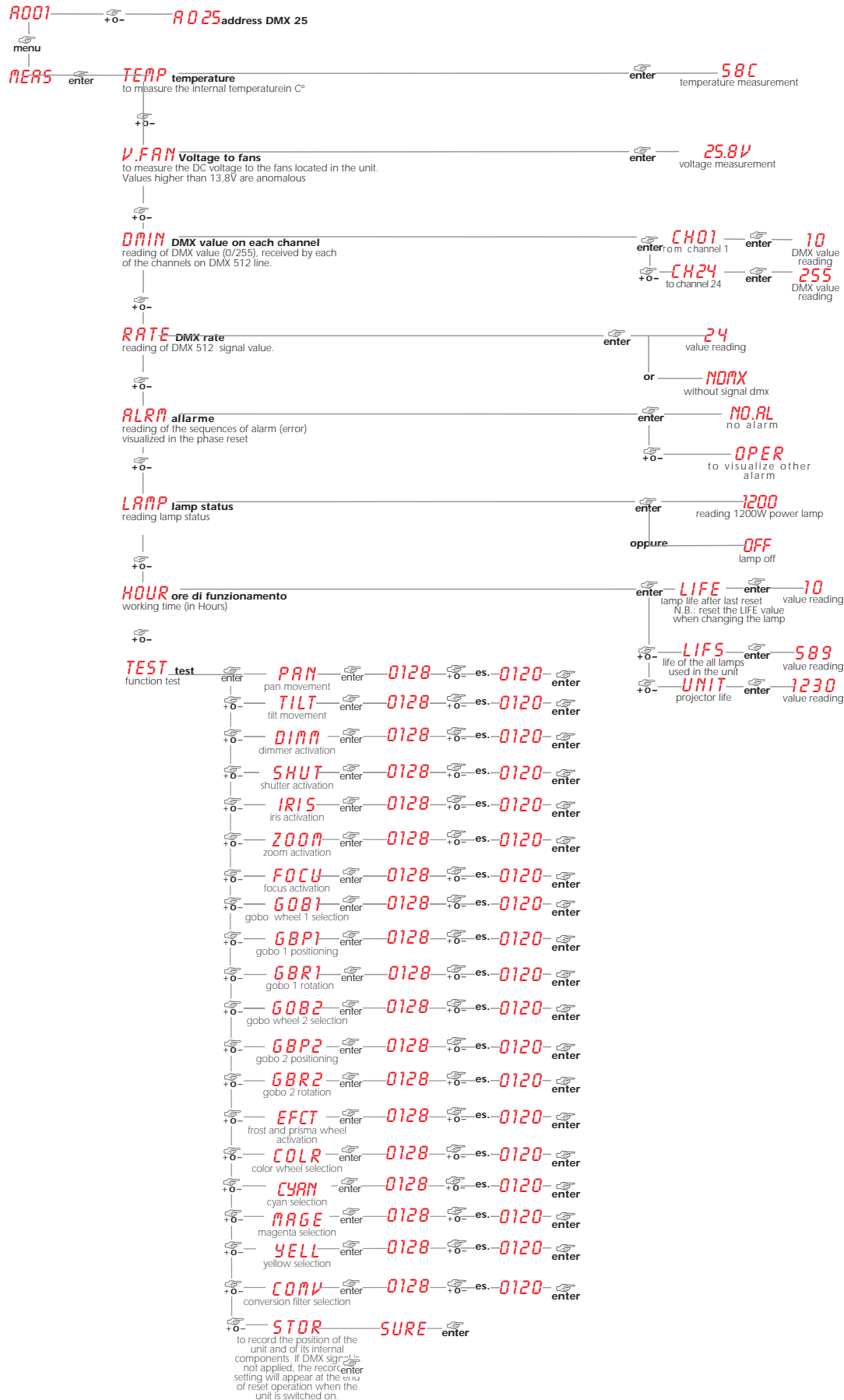

### 11.3. Quick guide to menu navigation

For your convenience, the following is a guide to navigating the menu system of the projector.

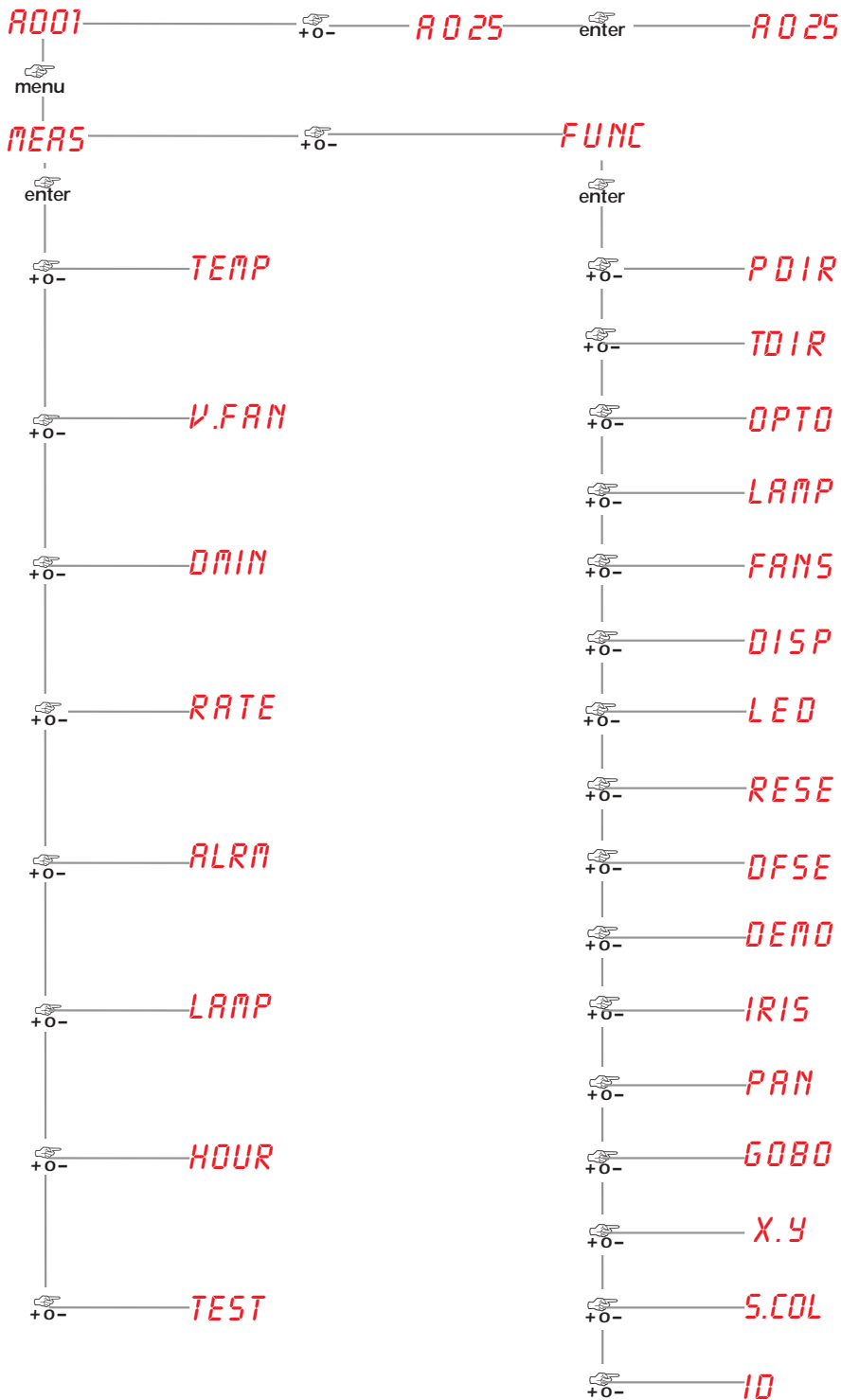

### 11.4. Rapid scrolling

Via the **iSpot 1200** display, it is possible to rapidly scroll through the various numbers displayed in the menu which apply to the following 3 uses:

- 1) Pressing down and holding the + or - buttons will cause the numbers to scroll more quickly than by simply pressing buttons repeatedly
- 2) Pressing down the + button and then the - button and holding them down simultaneously will cause the numbers to jump to the highest possible value available in the particular function.
- 3) Pressing down the - button and then the + button and holding them down simultaneously will cause the numbers to jump to the lowest possible value available in the particular function.

## 12. Aligning the lamp in the optical path

Aligning the lamp in the optical system is achieved via the 3 adjusters at the rear of the projector. This procedure should be undertaken to properly align the lamp in the optical system and to avoid the possible overheating of the internal components due to the incorrect focusing of the beam onto components not intended to be exposed to this.

### alignment procedure

Alignment is effected via the 3 adjusters A, B and C operating in conjunction with each other. The lamp should be on, black-out and dimmer fully open, and no colour filters inserted. If the lamp is not correctly aligned, a hot-spot will be noticeable. This is a function of the lamps positioning. Use the two adjusters (**B** and **C**) to bring the hot spot to the centre of the beam. Use the third adjuster (**A**) to flatten the beam to maximum uniformity.

### vertical adjustment

Adjuster (**C**) acts on a lever and spring assembly to position the lamp via a vertical movement within the reflector; rotate it until correct positioning is achieved.

### horizontal adjustment

Adjuster (**B**) acts on a lever and spring assembly to position the lamp via a horizontal movement within the reflector; rotate it until correct positioning is achieved.

### axial adjustment

Adjuster (**A**) moves the entire lamp assembly axially within the unit; rotate it until correct positioning is achieved, resulting in a flat, even beam.

**NB: It is extremely important that a uniform beam spread is achieved. Avoid creating a hot-spot in the beam as this may cause overheating of internal components, in particular the glass gobos.**

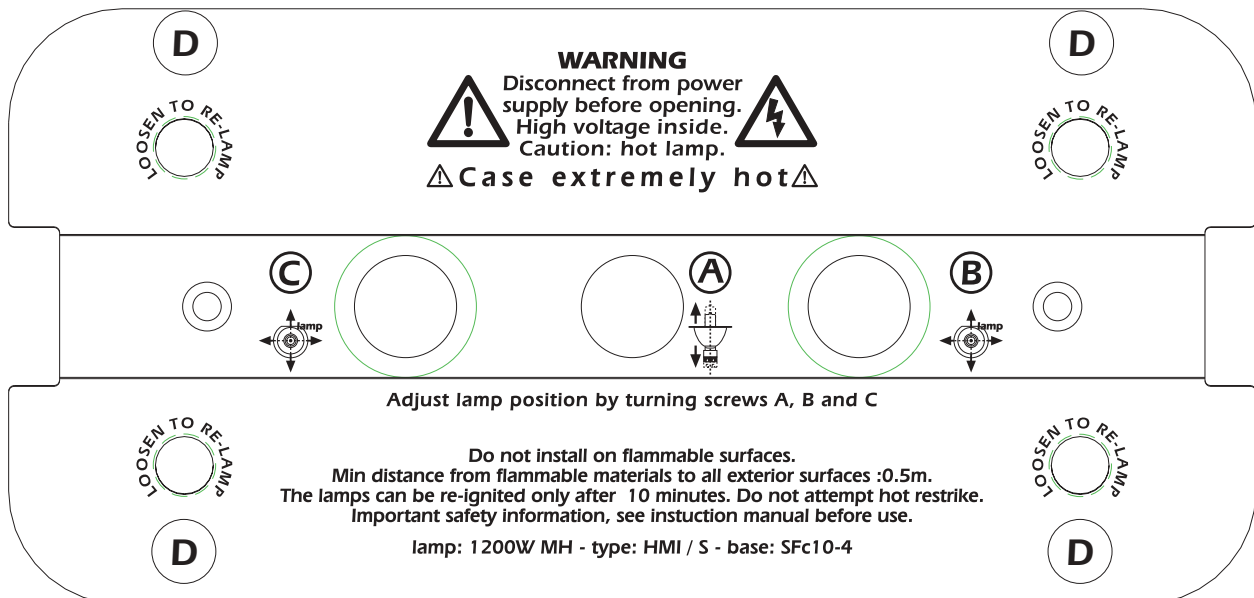

### 13. Turning on the ISPOT 1200 without articulated movement

This function may be useful should you need to power up the **ISPOT 1200** inside its roadcase or for any other reason where you may wish to power up the unit without it moving.

1) Power up the projector whilst simultaneously pressing the **enter**, **menu** and **-** buttons.

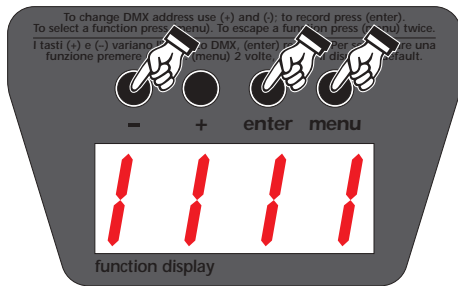

the projector will perform the usual reset functions on every motor barring the pan and tilt motor, which will remain static throughout the reset procedure..

- 2) You may at this point alter a DMX address, or any other menu-based parameter without projector articulated movement.
- 3) To resume normal **ISPOT 1200** functioning, you must turn the projector of and on again via the **power** button.

### 14. Resetting the counter

The electronic counter should be reset to zero hours every time the lamp is changed in order to provide accurate information about lamp life. Power up the **ISPOT 1200** whilst simultaneously holding the **+** and **-** buttons, the fixture will start up with the counter reset.

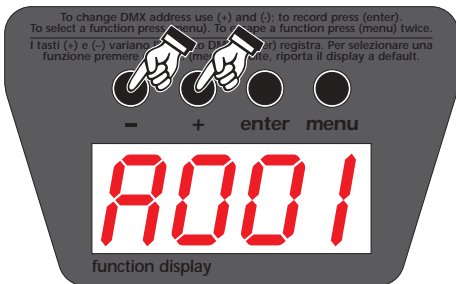

The projector will have effected a reset of the **LIFE** counter

To verify that the counter reset has been undertaken:

- 1) Press the **menu** button, the projector will show **MEAS**
- 2) Press the **+** or **-** button until **HOURL** is displayed
- 3) Press the **enter** button
- 4) Press the **+** or **-** button until **UNIT**.(number of hours of fixture operation)
- 5) Press the **enter** button
- 4) Press the **+** or **-** button until **LIFS**.(cumulative lamp life for all lamps installed)
- 5) Press the **enter** button
- 6) Press the **+** or **-** button until **LIFE** (lamp life) is displayed.
- 7) Press the **enter** button; the display will show **0000** confirming that the counter has been reset.

### 15. Automatic realignment

An internal 4 point encoder system allows the **iSpot 1200** to return to its correct position in case the unit is accidentally knocked out of alignment whilst operating. This is particularly useful if the projector is to be mounted on the floor in a position where the performer or artist may accidentally bump the unit.

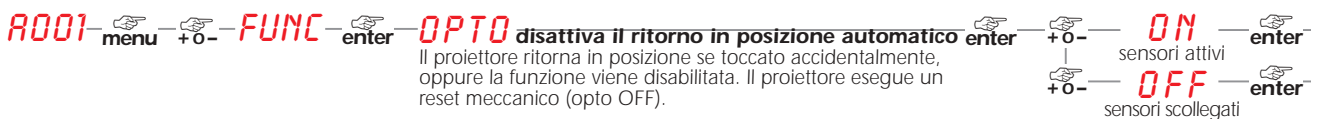

**NOTE:** this function is able to be disabled (Display panel functions **OPTO OFF** ).



## 16. DMX 512 signal functions

If you have correctly followed all the steps described up to this point, your **DMX 512** controller will allow you complete control of all the functions of the **ISPOT 1200** as described in the following table:

channel		function	type of control	effect	decimal		percentage	
16 bit	8 bit							
1	1	<b>X axis, base movement (pan) coarse</b>	proportional	proportional coarse control of the base motor movement	0	255	0%	100%
2	2	<b>X axis, base movement (pan) fine</b>	proportional	proportional fine control of the base motor movement	0	255	0%	100%
3	3	<b>Y axis, yoke movement (tilt) coarse</b>	proportional	proportional coarse control of the yoke motor movement	0	255	0%	100%
4	4	<b>Y axis, yoke movement (tilt) fine</b>	proportional	proportional fine control of the yoke motor movement	0	255	0%	100%
5	5	<b>movement speed</b>	step	standard (fast)	0	10	0%	4%
			step	ultra fast movement (best for programming positions)	11	25	4%	10%
			proportional	vector mode (from slow to fast)	26	127	10%	50%
			proportional	tracking mode (from fast to slow)	128	247	50%	97%
			step	tracking mode (slow)	248	255	97%	100%
6	6	<b>dimmer</b>	proportional	gradual adjustment of luminous intensity from 0 to 100%	0	255	0%	100%
7	7	<b>shutter, strobe</b>	step	shutter closed	0	9	0%	4%
			proportional	strobe effect with variable speed from slow to fast	10	66	4%	26%
			step	shutteropen	67	68	26%	27%
			proportional	sequenced pulse effect, slow closing, fast opening (with variable speed from slow to fast)	69	125	27%	49%
			step	shutteropen	126	127	49%	50%
			proportional	sequenced pulse effect, fast closing, slow opening (with variable speed from fast to slow)	128	184	50%	72%
			step	shutteropen	185	187	73%	73%
			proportional	random strobe effect, non-synchronised, variable speed from slow to fast	188	244	74%	96%
8	8	<b>iris diaphragm (LIN-Linear)</b>	step	open	0	9	0%	4%
			proportional	from maximum to minimum aperture	10	255	4%	100%
8	8	<b>iris diaphragm (with internal PULS effect)</b>	step	open	0	9	0%	4%
			proportional	from maximum to minimum aperture	10	124	4%	49%
			step	minimum diameter	125	129	49%	51%
			proportional	pulsing with proportional increase in speed	130	189	51%	74%
			step	open	190	192	75%	75%
			proportional	pulse and flash effect with proportional increase in speed	193	255	76%	100%
<b>NOTE 1:</b> the iris diaphragm operation will vary according to the selection made for IRIS on the display panel (linear LIN or with internal PULS effect)								
9	9	<b>focus</b>	proportional	proportional control of focus	0	255	0%	100%
10	10	<b>zoom</b>	proportional	proportional control of zoom from wide beam to narrow	0	255	0%	100%

channel		function	type of control	effect	decimal		percentage	
16 bit	8 bit							
11	11	rotating gobo selection on wheel 1 (closest to lamp) (STRD standard)	step	nogobo	0	10	0%	4%
				gobo1	11	40	4%	16%
				gobo2	41	70	16%	27%
				gobo3	71	100	28%	39%
				gobo4	101	130	40%	51%
				gobo5	131	160	51%	63%
			gobo6	161	192	63%	75%	
proportional	continuous rotation of the gobo wheel from slow to fast	193	255	76%	100%			
11	11	rotating gobo selection on wheel 1 (SPEC special)	step	nogobo	0	10	0%	4%
			proportional	proportional positioning of gobo wheel 1 at 360°	11	192	4%	75%
			proportional	continuous rotation of gobo wheel from slow to fast	193	255	76%	100%
<b>NOTE 2:</b> depending on the gobo selection on display panel (standard STRD or proportional SPEC) the gobo wheel has a different function								
12	12	indexing gobo rotation on wheel 1 through 360°	step	no effect	0	10	0%	4%
			proportional	proportional indexing of the gobos through 360°	11	255	4%	100%
13		fine indexing of the gobos 16 bit	proportional	fine indexing of the gobo (gobo wheel 1)	0	255	0%	100%
14	13	gobo rotation on wheel 1	step	no effect	0	10	0%	4%
			proportional	continuous rotation of the gobo in a clockwise direction with proportional control over decreasing speed	11	131	4%	51%
			step	gobostop	132	134	52%	53%
			proportional	continuous rotation of the gobo in an anti-clockwise direction with proportional control over increasing speed	135	255	53%	100%
<b>NOTE 3:</b> when channel 12 is set to a level between 0 and 10, gobo rotation (channel 14 at 16bit or channel 13 at 8bit) does not effect indexing, the gobo stops instantly								
15	14	rotating gobo selection on wheel 2 (STRD standard)	step	nogobo	0	10	0%	4%
				gobo 1	11	40	4%	16%
				gobo2	41	70	16%	27%
				gobo3	71	100	28%	39%
				gobo4	101	130	40%	51%
				gobo5	131	160	51%	63%
			gobo6	161	192	63%	75%	
proportional	continuous rotation of the gobo wheel from slow to fast	193	255	76%	100%			
15	14	rotating gobo selection on wheel 2 (SPEC special)	step	nogobo	0	10	0%	4%
			proportional	proportional positioning of gobo wheel 2 at 360°	11	192	4%	75%
			proportional	continuous rotation of gobo wheel from slow to fast	193	255	76%	100%
<b>NOTE 4:</b> depending on the gobo selection on display panel (standard STRD or proportional SPEC) the gobo wheel has a different function								
16	15	indexing gobo rotation on wheel 2 through 360°	step	no effect	0	10	0%	4%
			proportional	proportional indexing of the gobos through 360°	11	255	4%	100%
17		fine indexing of the gobos 16 bit	proportional	fine indexing of the gobo (gobo wheel 2)	0	255	0%	100%
18	16	gobo rotation on wheel 2	step	no effect	0	10	0%	4%
			proportional	continuous rotation of the gobo in a clockwise direction with proportional control over decreasing speed	11	131	4%	51%
			step	gobostop	132	134	52%	53%
			proportional	continuous rotation of the gobo in an anti-clockwise direction with proportional control over increasing speed	135	255	53%	100%
<b>NOTE 5:</b> when channel 16 or 15 (16bit or 8bit) is set to a level between 0 and 10, gobo rotation (channel 18 at 16bit or channel 16 at 8bit) does not affect indexing, the gobo stops instantly								

channel		function	type of control	effect	decimal		percentage	
16 bit	8 bit							
19	17	selecting frost and prisms + rotation	step	noeffect	0	10	0%	4%
			proportional	insert frost filter in the optical path	11	99	4%	39%
			step	prism 1	100	105	39%	41%
			proportional	continuous rotation of prism 1 in an anticlockwise direction, with proportional control over speed from maximum to minimum	106	137	42%	54%
			step	stop rotation prism 1	138	142	54%	56%
			proportional	continuous rotation of prism 1 in a clockwise direction, with proportional control over speed from minimum to maximum	143	174	56%	68%
			step	stop rotation prism 1	175	179	69%	70%
			step	prism 1	180	184	71%	72%
			proportional	continuous rotation of prism 2 in an anticlockwise direction, with proportional control over speed from maximum to minimum	185	216	73%	85%
			step	stop rotation prism 2	217	221	85%	87%
proportional	continuous rotation of prism 2 in a clockwise direction, with proportional control over speed from minimum to maximum	222	255	87%	100%			
20	18	selecting saturated colours from the colour wheel	step	no colour, white beam	0	5	0%	2%
				colour 1	6	14	2%	5%
				colour 2	15	22	6%	9%
				colour 3	23	30	9%	12%
				colour 4	31	38	12%	15%
				colour 5	39	45	15%	18%
			proportional	from colour 5 to colour 1, proportional positioning	46	127	18%	50%
				rainbow effect from fast to slow in an anticlockwise direction	128	190	50%	75%
			rainbow effect from slow to fast in a clockwise direction	191	255	75%	100%	
21	19	cyan	proportional	proportional control of the percentage of cyan colour in the light beam from 0 to 100%	0	255	0%	100%
22	20	magenta	proportional	proportional control of the percentage of magenta colour in the light beam from 0 to 100%	0	255	0%	100%
23	21	yellow	proportional	proportional control of the percentage of yellow colour in the light beam from 0 to 100%	0	255	0%	100%
24	22	conversion filters	step	no colour temperature correction, open beam to 7000K	0	58	0%	23%
				colour temperature of the light beam from to 6000K	59	106	23%	42%
				colour temperature of the light beam from to 5200K	107	154	42%	60%
				colour temperature of the light beam from to 4200K	155	202	61%	79%
				colour temperature of the light beam from to 3200K	203	250	80%	98%
				colour temperature of the light beam from to 10000K	251	255	98%	100%
25	23	slide effect	step	noeffect	0	249	0%	98%
			step	black-out of the light beam during PAN/TILT movement, colour and gobos	250	255	98%	100%
26	24	lamp on/off, all motor resets	step	park, no function	0	10	0%	4%
				lamp off	11	29	4%	11%
				pan and tilt reset (once only)	30	65	12%	25%
				reset all motors except black-out, pan and tilt (once only)	66	100	26%	39%
				reset all motors except black-out (once only)	101	135	40%	53%
				reset all motors (once only)	136	170	53%	67%
				lamp on	171	255	67%	100%
<b>Note 6:</b> the display panel may be used to disable the switching off of the lamp via DMX								
<b>Note 7:</b> turning off the lamp and all reset functions are delayed by 6 seconds to prevent accidental activation								
<b>Note 8:</b> the lamp on/off function can only be effected if an opposite level is set								

## 17. Opening up the projector

By removing the fixture's housing, complete access is available to the internals of the projector.

### Attention

Always remove mains power prior to accessing the internal components of the projector.

### Base housing

Use a Philips head screwdriver to remove the 4 screws which affix the front and rear base housings, as shown in the following diagram.



### Projector housing

Use a Philips head screwdriver to remove the projector housings, as shown in the following diagram.



## 18. Gobo positioning

The diagrams below illustrate how to correctly position the various types of gobos.

Treated side facing the lamp

Untreated side facing the projector front

Treated glass Gobos



Textured side facing the lamp

Smooth side facing the projector front

Textured glass Gobos



Reflective side facing the lamp

Treated side facing the projector front

Metal Gobos



Positive image / readable text facing the lamp

Negative image / reversed text facing the projector front

Image/Text Gobos



## 19. Interchanging gobos

**ISPOT 1200** utilises a mechanical system which allows the fixtures gobos to be removed without the need for specialised equipment. Replacement gobos should be made of either heat resistant glass or metal. An ever-increasing range of gobos is available from your **coemar** sales network.

### replacing gobos

gobo dimensions are as follows:

gobo wheel 1 (closest to the lamp):

ø external = 32,9 mm

ø image = 26 mm

thickness = from 0,2 to 3,5 mm

gobo wheel 2:

ø external = 32,9 mm

ø image with defined borders = 28 mm

ø image with non-defined borders = 30 mm

thickness = from 0,2 to 3,5 mm

Gobos should be replaced only when the projector is unpowered.

1- Open the projector housing as described in the preceding section.

2- Loosen the thumbscrews **A**, **B**, **C** and **D** as shown in this diagram

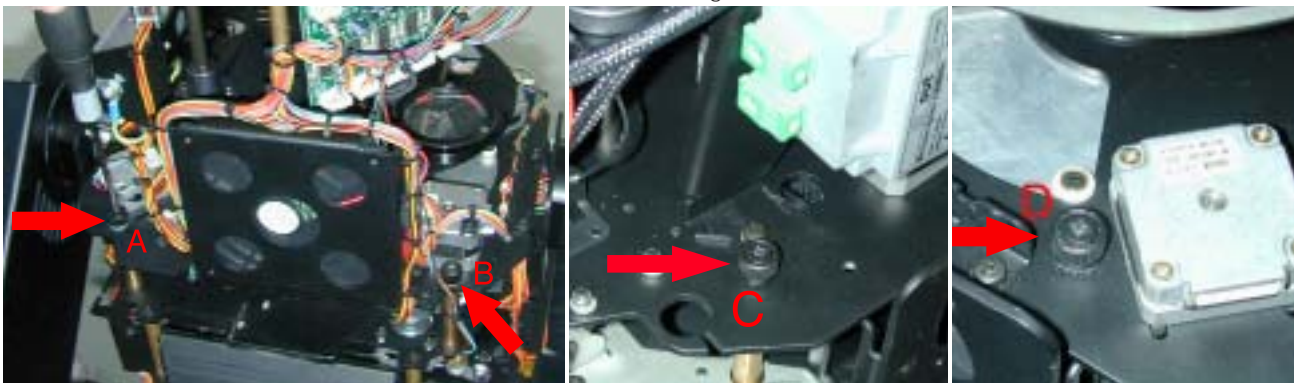

3) At this point, remove the gobo group as shown in the diagram. You will the gobo wheels in a position where access to the individual gobos is quite straightforward.



Proceed with the changing of the individual gobos as required.

**A) replacing gobos on gobo wheel 1:**

use a tool such as a screwdriver as a lever on the spring on the inside of the gobo wheel (see fig.1), lifting it from its seat (see fig.2), after which you can remove the gobo.

Place the new gobo into position and reverse the above procedure, ensuring that the spring sits firmly back in its proper place (see fig.3)

Fig.1

Fig.2

Fig.3



**B) replacing gobos on gobo wheel 2:**

use a screwdriver to loosen the screw **D** as shown in diagram 4, then sliding the lever towards the top (see Fig.5)

Fig.4

Fig.5

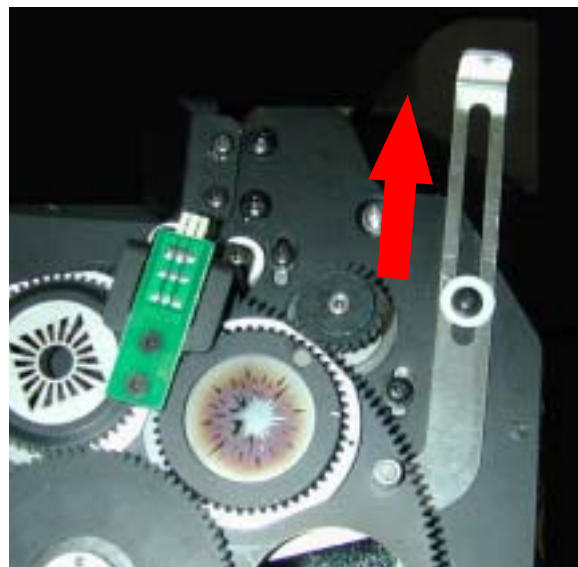
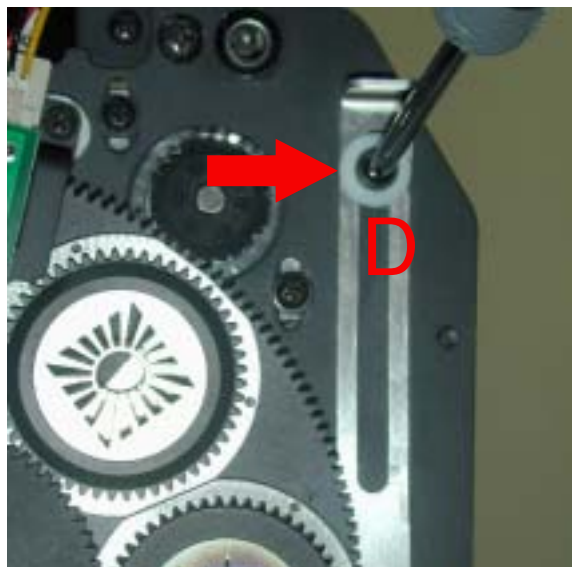

On the opposite side, you will note an opening as shown in figure 7

Fig.6

Fig.7



At this point proceed as per section A (**replacing gobos on gobo wheel 1**). Following this, proceed as in section B (**replacing gobos on gobo wheel 2**), following the procedures shown in Fig.5 and in Fig.4, sliding the lever in the opposite direction in order to close up the opening and retightening screw **D** as shown in Fig.4

## 20. Altering the operating voltage (reserved for technical personnel)

If the factory preset operating voltage and frequency do not correspond to those in use in your country of operation, you may alter the settings as described in the following paragraphs.

**Incorrect selection of operating voltage and frequency will seriously compromise the functioning of the projector.**

### 20.1. Selecting the transformer voltage

1) Loosen the screws on the cover of the base of the unit, as shown in the diagram below, using a Philips head screwdriver, thereby removing the cover completely and allowing access to the internal components of the base of the **ISPOT 1200**.



- 2) Locate the autotransformer in the base of the unit.
- 3) Select a voltage from amongst 208, 230 and 240V by removing cable n° 5 and moving it to the required voltage. To determine which is the correct tap, refer to the sticker located on the autotransformer.

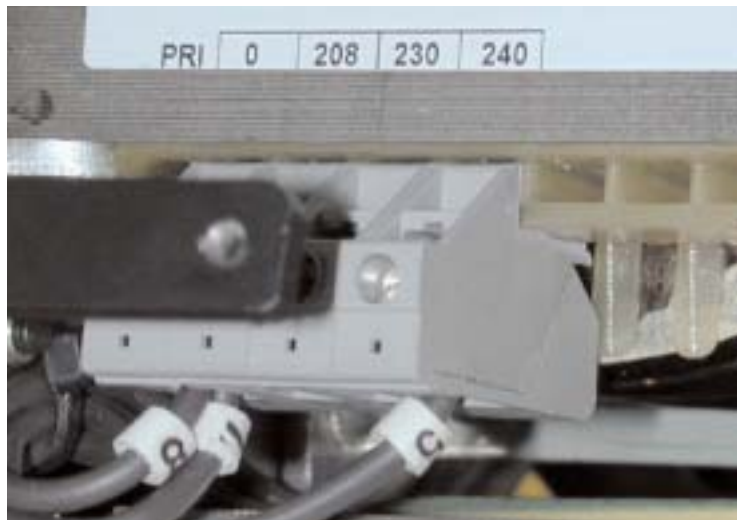
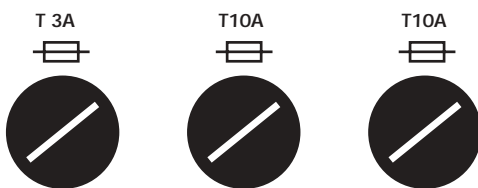

4) Make a note on the outside of the **ISPOT 1200** the new voltage which you have selected.

**factory set  
main at:**

- 208V
- 230V
- 240V

- 
- 50Hz
  - 60Hz

- 5) Close up the base with the housing covers as they were originally.
- 6) As shown in the diagram below, make a note on the outside of the **ISPOT 1200** the new voltage which you have selected.



## 21. Thermal protection

A thermal sensor in the body of the **ISPOT 1200** protects the unit against overheating. The thermal sensor removes power from the lamp should the ambient temperature exceed the set maximum or if there is a lack of air flow or there is a fan malfunction.

## 22. Lamp circuit protection

One timer operate within the projector to protect the lamp ignitor and power supply against prolonged operation in non-ideal conditions.

A software timer reattempts lamp ignition for a period of 20 seconds in every minute for up to 8 minutes; then it preserves the lamp circuit by not allowing high voltage to the lamp (assuming the lamp to have passed its useful life).

**NOTE:** it is important to remove power from the fixture if the lamp has reached the end of its life and to replace the lamp.

## 23. Maintenance

Whilst every possible precaution has been taken to ensure the trouble-free operation of your **ISPOT 1200**, the following periodic maintenance is highly recommended. Mains voltage should be removed prior to attempting any maintenance procedure.

### Attention

Disconnect mains power prior to removing the projector housing.

To gain access to the internals of the unit refer to section **17. Opening up the projector.**

### periodic cleaning lenses and reflectors

Even a fine layer of dust can reduce the luminous output substantially. Regularly clean all lenses and the reflector using a soft cotton cloth, dampened with a specialist lens cleaning solution.

### fans and air passages

The fans and air passages must be cleaned approximately every 6 weeks; the period for this periodic cleaning will depend, of course, upon the conditions in which the projector is operating. Suitable instruments for performing this type of maintenance are a brush and a common vacuum cleaner or an air compressor.

### periodic maintenance lamp

The lamp should be replaced if there is any observable damage or deformation due to heat. This will avoid the danger of the lamp exploding.

### mechanicals

Periodically check all mechanical devices for wear and tear; gears, guides, belts, etc., replacing them if necessary. Periodically check the lubrication of all components, particularly the parts subject to high temperatures. If necessary, lubricate with suitable lubricant, available from your **coemar** distributor.

### electrical components

Check all electrical components for correct earthing and proper attachment of all connectors, refastening if necessary.

### fuse replacement

Locate the fuse, which protects the lamp and electronics, on the base panel of the **ISPOT 1200**. Using a multimeter, test the condition of the fuse, replacing it with one of equivalent type if necessary..

## 24. Electronic motor alignment

### Attention!

This section is reserved only for technical and specialist personnel.

The display panel of the **ISPOT 1200** allows for the electronic alignment of the projector's motors in the optical system. This procedure is performed by **coemar** at the factory. It may be useful to perform this procedure in the case of internal components being replaced.

Altering the factory settings may radically alter the functioning of the projector. Carefully read all of the following prior to attempting any changes.

### electronic calibration

### Attention!

Electronic calibration is only possible if the projector is receiving DMX 512 signal.

- 1) Press the **menu** button.
- 2) Press the **+** or **-** button until the display shows **RESE** (for reset).
- 3) Press the **enter** and **menu** buttons simultaneously and hold for at least **30"**. The motors of the unit will perform a reset and the display will show **---** for some few seconds, indicating that you have entered the electronic calibration mode:

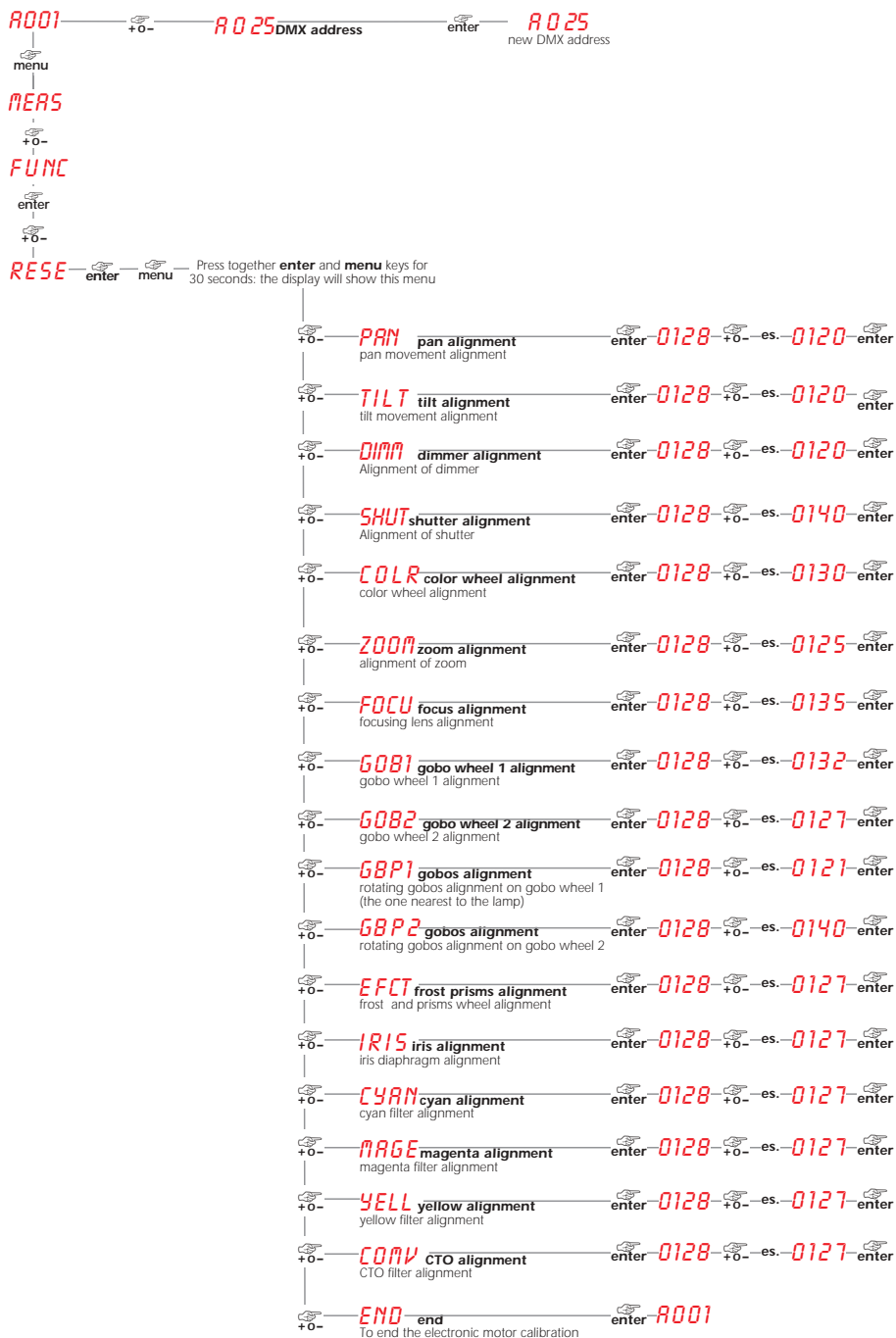

**Note:** Simultaneously pressing the **+** and **-** buttons will return the calibration value to the default value of 128.

## 25. Error messages

<b>MBER:</b>	<b>COMMUNICATION Error</b> This message indicates that the motherboard within the unit is not communicating properly with the control source. Check the connectors located on both boards.
<b>OPER:</b>	<b>PAN ENCODER Error</b> This message indicates that there is a problem with the PAN encoders. Check the sensors on the encoder wheel located near the pan movement motor, as well as the relevant cabling.
<b>OTER:</b>	<b>TILT ENCODER Error</b> This message indicates that there is a problem with the TILT encoder locate on the fixture yoke. Check the sensors on the encoder wheel located near the pan movement motor, as well as the relevant cabling.
<b>EPER:</b>	<b>EEPROM Error</b> The EEPROM is either defective or absent; refer to your coemar service centre for a replacement component.
<b>OTER:</b>	<b>DATAQ Error</b> The initial parameter settings are incorrect or corrupt; the projector has reloaded its factory default settings. Turn the projector off and on again. Should the error reoccur, refer the unit to your authorised coemar service centre to have the EEPROM check and possibly replaced.
<b>SNER:</b>	<b>SYNCHRONISM OF LINE Error</b> To check and eventually to replace the opto insulating U9
<b>ADER:</b>	<b>DMX Addressing Error</b> The projector is not receiving all DMX channels needed to operate correctly. Check the DMX address indicated on the display and the channel numbers being outputted from the controller. Note that not all controllers will output all 512 channels.
<b>SZER:</b>	<b>Control circuit error relating to position sensors controlling the 4 right-hand motors :(located in the yoke at right when viewed from the rear or the unit)</b> Sensor is continuously reading the magnet. Check the cabling and the RESET sensors the motors and the integrity of the connecting belts.
<b>S3ER:</b>	<b>Control circuit error relating to position sensors controlling the 5 rear motors:(located in the rear of the body when viewed from the rear of the unit)</b> Sensor is continuously reading the magnet. Check the cabling and the RESET sensors the motors and the integrity of the connecting belts.
<b>S4ER:</b>	<b>Control circuit error relating to position sensors controlling the 5 front motors:(located in the front of the body when viewed from the rear of the unit)</b> Sensor is continuously reading the magnet. Check the cabling and the RESET sensors the motors and the integrity of the connecting belts.
<b>COER:</b>	<b>COLOUR WHEEL POSITION Error</b> Check for correct functioning of the motor and the magnetic sensor of the COLOUR wheel.
<b>CUER:</b>	<b>CONVERSION FILTER POSITION Error</b> Check for correct functioning of the motor and the magnetic sensor of the CONVERSION wheel.
<b>G1ER:</b>	<b>GOBO WHEEL 1 POSITION Error</b> Check for correct functioning of the motor and the magnetic sensor of GOBO WHEEL 1 (closest to the lamp).
<b>G2ER:</b>	<b>GOBO WHEEL 2 POSITION Error</b> Check for correct functioning of the motor and the magnetic sensor of GOBO WHEEL 2 (furthest to the lamp).
<b>R1ER:</b>	<b>INDEXING ON GOBO WHEEL 1 Error</b> Check for correct functioning of the motor and the magnetic sensor for GOBO INDEXING for gobo wheel 1 (closest to the lamp).
<b>R2ER:</b>	<b>INDEXING ON GOBO WHEEL 2 Error</b> Check for correct functioning of the motor and the magnetic sensor for GOBO INDEXING for gobo wheel 2 (furthest to the lamp).
<b>EFER:</b>	<b>FROST/PRISM FILTER POSITION Error</b> Check for correct functioning of the motor and the magnetic sensor of the FROST/FILTER wheel.
<b>ZOER:</b>	<b>ZOOM LENSE POSITION Error</b> Check for correct functioning of the motor and the magnetic sensor of the ZOOM lense.
<b>FCER:</b>	<b>FOCUS LENSE POSITION Error</b> Check for correct functioning of the motor and the magnetic sensor of the FOCUS lense.
<b>ER20 ÷ ER99:</b>	<b>SYSTEM Error</b> Turn the unit off and on again. If the error persists, contact your authorised coemar service centre.

## 26. Parti di ricambio

All the components of the **ISPOT 1200** are available as replacement spares from your authorised **coemar** sales agent. Accurate description of the fixture, model number, and type will assist us in providing for your requirements in an efficient and effective manner.

## 27. Troubleshooting

Question	Possible cause	Possible solution
The projector is completely immobile.	Projector not powered up.	Check that the mains power cable is connected to power (see pages 7 to 9).
	The circuit breaker is switched off	Set the circuit breaker to ON.
	The protection fuse is blown	Disconnect the projector and replace the fuse.
The projector resets correctly, but either does not respond, or responds incorrectly, to DMX signal.	Incorrect signal connection	Inspect the signal cable, rectify any incorrect wiring, repair or replace any damaged cables or connectors.
	Incorrect DMX address	Check the DMX address.
	The wiring of the canon plug may be incorrect.	Repair or replace the signal cable
No light output and the display shows the message "LAER".	The lamp may have reached the end of its life.	Disconnect mains power and check the lamp condition, checking the lamp life display (see section 11.2 - page.13)
	The lamp is not installed.	Disconnect mains power and install a lamp.
	The lamp circuit protection fuse may be blown	Check with your coemar service centre prior to replacing the fuse.
The lamp turns off intermittently	The projector is too hot.	Let the fixture cool down. Check that the air vents above the cooling fans are not obstructed and that the fans are working correctly. Ensure that the ambient temperature is below 35 °C.



**coemar spa**

via Inghilterra  
46042 Castelfreddo (Mantova) Italy  
Tel. 0376/77521  
Fax 0376/780657

**Coemar** si riserva il diritto di apportare modifiche senza preavviso.  
**Coemar** reserves the right to effect modifications without notification

manuale istruzioni  
instruction manual

**ISPOT 1200**

1<sup>^</sup> edizione Novembre 2004  
1<sup>st</sup> edition November 2004